

SPIROFLOW

GLOBAL LEADERS IN MATERIAL HANDLING

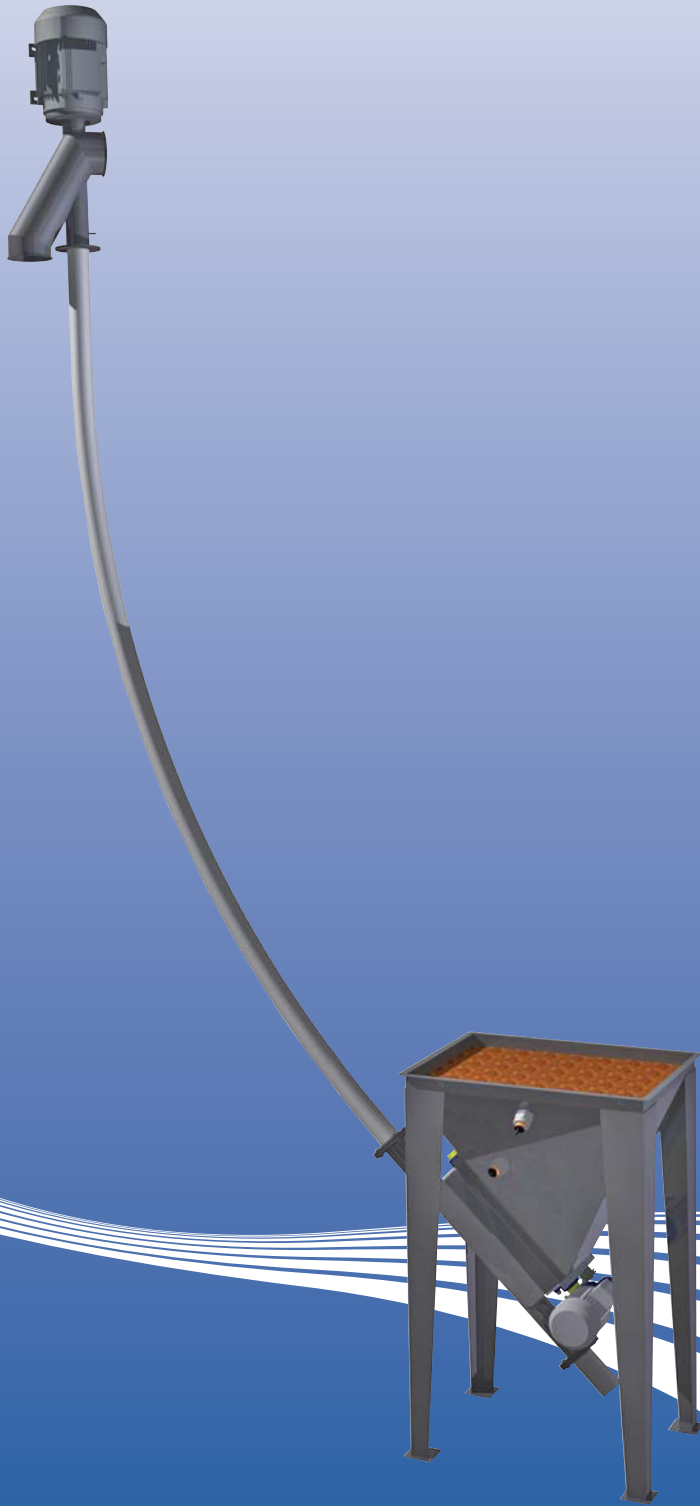

Flexible Screw Conveyors
for dry bulk solids and ingredients

CONVEYING SOLUTIONS

for dry bulk solids and ingredients

Internationally recognized as the leading name in the design and manufacture of spiral conveying systems, Spiroflow has been serving industries handling the widest range of dry bulk solids and ingredients for over 35 years!

"Our ability to fully understand our customers' needs, design a customized solution for their process and to provide the best technical expertise with which to support them before and after the sale have been our hallmark since inception" Michel Podevyn - Founder.

Design simplicity

Sheer simplicity of operation is the key element in the Spiroflow conveying system. The electric motor driven spiral, which is the only moving part, rotates within a sealed tube, moving the materials along by its archimedean screw action.

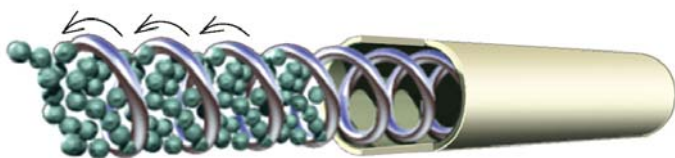

This design simplicity eliminates the need for any additional operating equipment such as filters or bearings - all adding up to a system that's hygienic, easy to clean, low on installation and maintenance costs and high on efficiency and performance.

Dust free

During the materials conveying process, even the most harmless ingredients can become a hazard when they appear as dust in the atmosphere. In addition to the resulting downtime spent cleaning floors and equipment, the presence of dust can cause airborne contamination of other products, and also pose a threat to the working environment.

The 'Spiroflow' conveying system is totally sealed during operation, and because air is not used as the conveying medium, there is no need for filtration nor is there a risk of dust contamination escaping in to the atmosphere - critical for applications involving active pharmaceuticals and hazardous chemicals.



Easy to clean

The simplicity of the Spiroflow conveying system makes cleaning a simple operation. Conveyors can be emptied of residual material by reversing the motor and then dry cleaned by brushing or, if necessary, flushed through with water or cleaning solution. Optional, interlocked, quick release connectors facilitate rapid dismantling and reassembly where dry cleaning of the spiral, tube and end connections is essential.



Gentle handling

The rotating spiral is centralized in the tube by the product and as a result there is little to no product degradation. Spiral type and speed are carefully chosen to ensure your product is conveyed in the optimum manner. We have over 35 years of experience logged in our database - backed by comprehensive test facilities where customers can see just how gentle our conveyors are for themselves.



Constant remixing

The unique action of the flexible spiral conveyor eliminates the risk of product separation that can take place in conventional pneumatic conveying systems where mixed materials have components of differing densities and/or particle size. In fact, the 'Spiroflow' system ensures constant remixing; restoring every part of the mix to its desired proportions many times a second. This is essential when feeding pre-mixed ingredients to packaging and tableting machines.

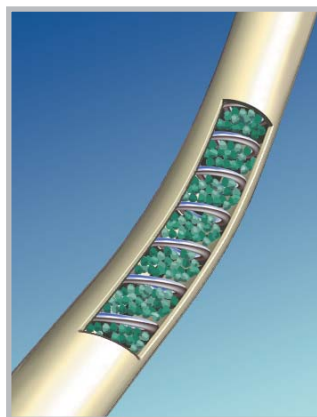

Low maintenance

As the only moving part of a Spiroflow conveyor is its robust inner spiral, trouble-free operation is ensured. Our spirals are specially heat-treated and tempered for maximum working life.



FLEXIBILITY by design

Materials testing

Our in-plant testing facility can quickly evaluate the flow characteristics of any kind of material from samples supplied by the customer. To back up this service, we have, over many years, built a large database of the flow properties of thousands of materials, giving ready information on the solutions to many conveying problems. Just a small sample can help us to take the guesswork out of predicting conveyor performance.

Where products have poor flow properties, such as light, high fat or cohesive powders, these can be overcome with the addition of agitators, or other flow aids at the conveyor inlet. If hygroscopic products such as sugar, could be affected by moisture ingress, fans or fast acting valves at the outlet ensure minimum atmospheric exposure.



Easy installation, minimum disruption

The flexibility of 'Spiroflow' conveying systems is unlimited. They can be configured to convey in any direction and in any elevation between horizontal and vertical. They can be installed over, under and around existing plant and equipment. And they can easily be maneuvered round obstacles and through small openings in walls to maximize valuable factory space. Multiple conveyors linked outlet to inlet enable conveying over longer distances. Multiple inlets and/or multiple outlets are possible on a single conveyor to create a distribution system such as transferring ingredients from storage to a line of processing or packaging machines.



Heavy duty conveyors

We offer a range of heavy duty conveyors with Ultra High Molecular Weight Polyethylene (UHMWPE) tubes for abrasive or high bulk density materials. For the most abrasive of metals, aggregates and for materials such as glass cullet, we offer our RHINOVEYOR Flexible Screw Conveyor which has an abrasion resistant rubber conveying tube in addition to a heavy duty spiral. Tests and operational experience have confirmed that our RHINOVEYOR conveying tubes have a significantly longer life than standard UHMWPE plastic tubes in aggressive applications.



NEMA

We are well versed in the regulations for explosive atmospheres and as a result we can design control panels and equipment to comply.

For heavy duty applications, our range of 'Megaflow' centerless conveyors is capable of throughputs of up to 40 tons/hr.



APPLICATIONS in many industries

'Spiroflow' conveyors are installed world-wide in a multitude of industries because of their versatility and ability to take a wide range of particle size, bulk density and flow properties in their stride.



Food

Hygienic ingredients handling is the fundamental benefit of 'Spiroflow' equipment, designed to satisfy the stringent demands of the food and allied industries.



Water Treatment

Spiroflow assists in the protection of the environment by supplying efficient dosing equipment for hydrated lime, activated carbon and other chemicals used in water treatment.



Plastics and Rubber

Spiroflow solids handling equipment is widely chosen to ensure efficient feeding of moulding, extrusion and mixing machinery in the volume manufacturing sectors.



Pharmaceuticals

Accuracy, hygiene and consistent feeding are prime requirements in the pharmaceutical field.



Chemicals

Spiroflow's long experience within the chemicals industry ensures the safe handling and accurate metering of these often hazardous materials.



Mineral and Ceramics

No bulk handling tasks are more arduous than in minerals and ceramics. Spiroflow equipment is robustly built to meet the most exacting demands.

INTEGRATED HANDLING EQUIPMENT

Spiroflow offers a comprehensive range of related bulk solids and ingredients handling equipment which is usually integrated with our flexible screw conveyors.



Mobile conveyors

For added versatility, mobile conveyors are available mounted on robust, moveable frames with integral feed hopper. Easy to move and simple to operate, they are ideal for the intermittent feeding of several process machines. Additionally, they are easy to remove from the process area for cleaning elsewhere.



Bulk Bag dischargers

Spiroflow provides a full range of equipment for the discharge of materials from Bulk Bags. Many different models are available to meet the majority of industrial applications, including discharging by weight or volume, and with a host of optional features to satisfy individual requirements.



Rigid bin emptiers

Spiroflow designs vibrating discharge frames for all kinds of rigid metal and plastic IBCs and Octabins to ensure complete emptying of product into the integral flexible screw conveyor. Systems are fully sealed, dust-free and allow discharge of bins either by volume or by weight.



Sack emptiers

Spiroflow manufactures dustless sack emptiers with bag disposal facility if required, allowing sack contents to be discharged and transferred directly by Spiroflow conveyors to processing machines.

Typical applications

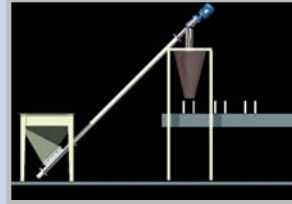

Conveying from hopper to process.

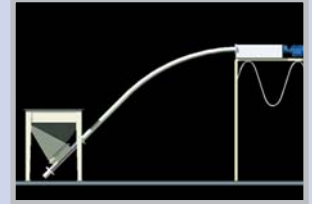

Horizontal outlet for restricted headroom.

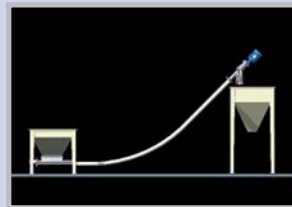

Feeding filling machinery.

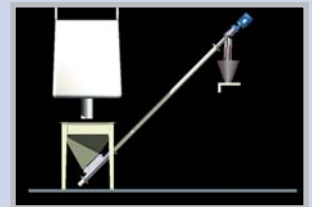

Feeding from Big Bags.

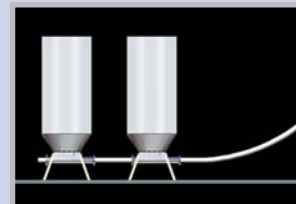

Multi-infeed conveyor.

Unusual applications



Water treatment system inside an ISO container

TECHNICAL DATA

Flexible screw basics



Control

Control equipment ranges from simple starters, level controls and timers to PLC systems enabling multi-ingredient recipe variations to be weighed, blended and conveyed.

- 1 Electric motor: 3 phase, 50/60hz, voltage as specified. Special motors also available to your specification. Fixed or variable speed.
- 2 Motor adaptor and spiral connector in mild steel or stainless steel.
- 3 45 degree or horizontal outlet assembly in mild steel/painted, or stainless steel.
- 4 Dust-tight tube fitting.
- 5 High and low level control.
- 6 Abrasion resistant food grade polymer or tough rubber conveying tube.
- 7 Flexible spiral in spring steel or stainless steel.
- 8 Inlet assembly in mild steel / painted, or stainless steel.
- 9 Feed restrictor to regulate material flow.
- 10 Feed hopper in standard size or to customer's specifications.
- 11 Optional agitator for difficult materials.

Model specifications

Model	Capacity lbs/hour (approx)	Minimum bend radius (ft)	Tube Diameter (in)
214	1000	6'	2 1/4"
258	2000	8'	2 5/8"
318	4800	14'	3 1/8"
412	14000	20'	4 1/2"
658	26000	N/A	6 5/8"
834	58000	N/A	8 3/4"

Throughput rate varies depending on bulk density, material behaviour, conveyor length and layout. We recommend testing to determine the correct model. Capacity is based on materials with a density of 50 lbs/cu.ft.

Spiral profiles

For most applications, the standard round spiral is suitable, combining strength and flexibility. Flat section spirals are recommended for certain light or aereated products.

The Pro Screw beveled profile is used for conveying difficult materials such as iron oxide. Semi-rigid construction enables steep conveying angles to be achieved without bends.

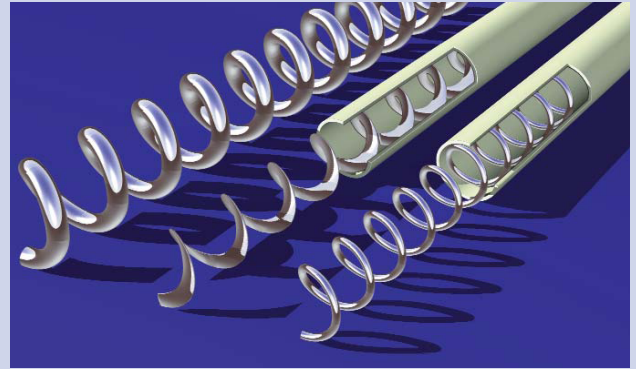

The center core is used for very light materials that fluidize readily and for conveyors inclined more than 60°. They are also used to prevent flooding/overfeeding of certain solids in short or horizontal conveyors.

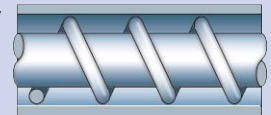

All spirals are heat treated to provide strength and long life. Heavy duty spirals are also available for certain high density or aggressive materials.

Standard 3 phase electric motor, fixed or variable speed. Special motors can be supplied to individual specification.

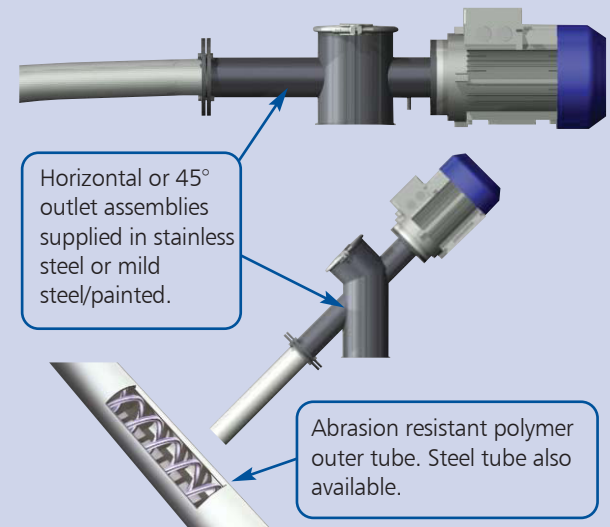

POWDER HANDLING SYSTEMS



Design

We have an experienced team of mechanical and electrical engineers with a vast collective knowledge of solids handling, geared to handle your project quickly and efficiently, whether you need a single conveyor or a complete powder handling system.

Testing

Our fully equipped test facility, which is at your disposal, assesses performance of our machinery on your particular material. On-site trials can also be arranged if preferred.

Manufacturing

We actively encourage customers to visit our modern manufacturing facility at any time. Here, we are able to process orders efficiently and to our high quality standards. We also have a similar manufacturing facility in the UK.

After sales

At Spiroflow, we firmly believe that after sales service forms an integral part of the product. Over 70% of our business comes from existing customers, whom we work with as partners from the moment of placing an order and throughout the equipment's operational life.

Other equipment in the Spiroflow range:

- Pneumatic and vacuum conveyors
- Aero mechanical conveyors
- Bulk bag dischargers
- Sack, drum and IBC emptiers
- Bulk bag filling and weighing machines
- Batch and continuous weighing systems
- Silo and hopper discharge aids
- Continuous mixing systems

SPIROFLOW

GLOBAL LEADERS IN MATERIAL HANDLING

Spiroflow Systems Inc.

1609 Airport Road
Monroe, NC 28110, U.S.A.

Telephone: (1) 704 291 9595
Facsimile: (1) 704 291 9594
Email: info@spiroflowsystems.com
Website: www.spiroflowsystems.com

Spiroflow Limited

Lincoln Way, Clitheroe
Lancashire, BB7 1QG, U.K.

Telephone: +44 (0) 1200 422525
Facsimile: +44 (0) 1200 429165
Email: sales@spiroflow.com
Website: www.spiroflow.com