

spiroflo



Bulk Bag Discharging

BULK BAG DISCHARGERS for every application

Bulk bags have been around for over 25 years and Spiroflow has been there since the beginning. Whether you have been using bulk bags for years or are thinking about converting from bags, sacks, rigid containers or silos, then safe, efficient and dust-free handling methods are essential to gain maximum benefit.

We believe in providing complete and integrated solutions for specific powder handling applications. Many years of cooperation with large volume users of Bulk Bags have resulted in the development of a comprehensive and ever expanding range of dischargers and transfer equipment to suit your product and bag type. The advantages of handling solids and ingredients in Bulk Bags are obvious:

- Reduced labor
- Better dust control
- Increased safety
- Cleaner working environment
- Increased productivity
- No packaging waste

The advantages of working with Spiroflow are just as clear:

- 25 years of experience
- Dedicated testing facilities
- Advanced design & manufacturing facility
- A wide range of innovative designs & design options
- Experienced applications engineers
- Turnkey systems



Testing & demonstration



Good health & Safety practice requires, as a minimum, that the weight of a bulk bag be supported as it is unacceptable to support bags from their loops for any length of time where operators are present. It is certainly not good practice to use a forklift truck to hold a bag over a point of discharge. Additionally, it ties up the forklift preventing it from being used elsewhere.

In all but a very few applications, gone are the days where a local fabricator or a company's engineering team can 'throw together' a simple bulk bag discharger support frame. These can never match the safety, reliable discharge and containment offered by the specialist supplier and demanded by today's practices and legislation.

DISCHARGING BY VOLUME

Universal (T2)

Our Universal T2 provides controllable discharge by volume. Flow from the bulk bag is easily controlled by means of an integral Spiroflow conveyor directly coupled to the base of the discharger.

This type of conveyor can be used to accurately meter bulk bag contents to your process vessel in an enclosed and controlled manner.

Our powder handling expertise ensures a transfer method best suited to your product, whether it is by aero mechanical conveyor, flexible or rigid screw, pneumatically or otherwise.

Features

- Full dust control
- Designed to discharge poor flowing materials
- Suitable for all Bulk Bag types and sizes up to 6.5 ft. / 2 metres high & 4,500 lb. / 2 tonnes in weight
- Bag tensioning ensures total emptying of bag contents - no wastage or spillage
- Automatic transfer of contents via integral take-off conveyor
- Quiet operation (no vibrators)

Options

- Bag massagers to aid flow
- Bag spout closure bars for dust-free easy untying & re-tying of bag
- Liner remover
- Mobile frame
- Bag/Sack tip door
- Hygienic liner clamp

See pages 8, 10 and 11 for full list of options.

1. The loops of the bag are attached to a bag lifting frame and the liner is clamped.



2. The bag is lifted by a forklift truck on to the robust bulk bag support frame. Spring-loaded arms on the bulk bag support frame gradually raise and tension the bag during emptying. This ensures total emptying of the bag and prevents the bag spout or liner from sagging or fouling the take-off conveyor.



3. The integral chute has an access door for easy bag untying. The spout closure bars ensure the bag remains tightly closed until the emptying process starts.



4. The pneumatically operated massage system, adjustable in position for optimum effectiveness, ensures consistent flow of difficult products.



5. An integral conveyor transfers bag contents direct to your process.



DISCHARGING BY WEIGHT

Loss-in-weight Model (T3)

Our Loss-in-weight Bulk Bag Discharger allows you total control over the amount of product you wish to dispense from the bag. This can be varied for individually selected batch amounts, or fully interfaced with your plant process control for continuous batch production.

The T3 Loss-in-weight Bulk Bag Discharger incorporates all the proven features of the Universal model, but with the bag support dish mounted on load cells. This enables highly accurate weighing of product as it is discharged from the bag. If necessary, the integral transfer conveyor can also be suspended from the weigh frame as shown opposite, to provide a totally self-contained discharge and loss-in-weight dispensing unit.

Features

- Batch or continuous weight control with load cells located at mid-section to prevent risk of damage by forklift trucks
- Recipe management system
- Bag tensioner ensures complete emptying of bag contents
- Integral conveyor or feeder
- Full dust control
- Designed to discharge poor flowing materials
- Suitable for all bulk bag types and sizes up to 6.5' / 2 metres high & 4,500 lb. / 2 tonnes in weight
- Quiet operation (no vibrators)

Options

- Bag massagers to aid flow
- Bag spout closure bars for dust-free and easy untying & re-tying of bag
- Liner remover
- Mobile frame
- Bag/Sack tip door
- Hygienic liner clamp

See pages 8, 10 and 11 for full list of options

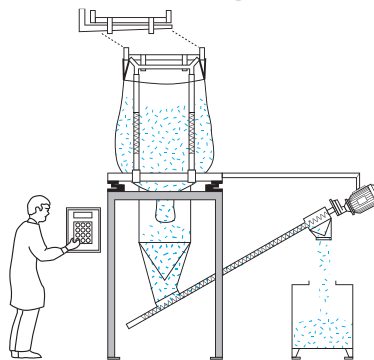

Our specialized batch controller provides both 'bulk' & 'trickle' feed for loss-in-weight dispensing. The Pause-Resume feature pauses the discharging operation when one bulk bag is empty and retains in memory the amount dispensed. When a fresh bulk bag is placed on the discharger, the controller recalls the remaining weight required and resumes discharging.

All components, including the bulk bag conveyor are 'above' the load cells and are weighed, while the lower frame (shaded) is isolated from the load cells and secured to the floor.



DISCHARGING WITH HEIGHT RESTRICTION

Low Loader Model (T5)

Spiroflow's T5 Low Loading Discharger empties bulk bags and bags/sacks in process areas where restricted headroom causes problems in handling bags or where only a low lift forklift truck is available.

The discharger is coupled directly to a flexible spiral or other suitable conveyor which meters ingredients from the bag either volumetrically or by weight. Ingredients may then be fed directly to either mixing or other process equipment to provide a fully automatic ingredients unloading, proportioning and transfer system.

The height of the access door has been designed to receive small bags/sacks, of particular benefit to processors who have switched over to bulk bags, but still continue to receive minor ingredients in 50 lb. / 25kg bags/sacks.

Processors with batching operations may choose to have several bag frames for use with one discharge station, allowing them to partially empty, re-tie and store bulk bags.

Features

- Removable top frame
- Dust-tight spring-loaded docking seal
- Bag tensioner ensures total emptying
- Integral conveyor or feeder
- Dust control

Options

- Loss-in-weight batch control
- Bag massagers to aid flow
- Bag spout closure bars for dust-free and easy untying and re-tying of bag
- Mobile frame
- Bag/Sack tip door
- Liner remover
- Hygienic liner clamp



The discharger base unit has a dust-tight docking seal on to which the top frame and bulk bag is placed. A spout clamp allows the bag to be untied without dust emission or spillage via an access door.



1. No bulk bag is in place



2. Loading bulk bag into top frame



3. Lifting top section from floor



4. Returning top section



5. Bulk bag is loaded & ready to discharge

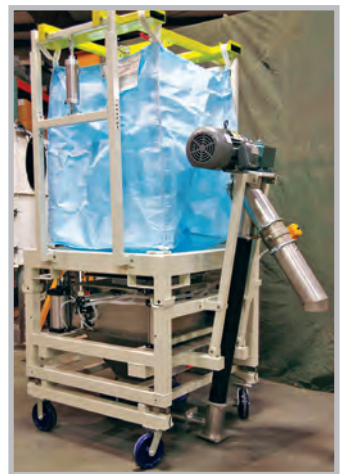

This special T3/T5 compact mobile discharger is designed to fit into an elevator/lift for travel between floors.

DISCHARGING IF NO FORKLIFT TRUCK IS AVAILABLE

Integral Hoist Model (T6)

Our T6 Bulk Bag Discharger is a fully self-contained unloading station for dust-free and controllable bulk bag emptying.

It has an integral "I" beam and hoist for loading bags into the discharger which is directly connected to an enclosed conveyor for direct transfer of product to process machinery. Bulk bags may be brought to the discharger by pallet truck and stored ready for lifting without the need for forklift truck assistance. Full dust control features are incorporated.

Features

- Space saving integral bag hoist with runway beam
- Dispensing of contents by volume or weight
- Integral conveyor or feeder
- Quiet operation
- No forklift truck required
- Full dust control

Options

- Bag massagers to aid flow
- Bag spout closure bars for dust-free and easy untying and re-tying of bag
- Liner remover
- Loss-in-weight batch control
- Extended gantry frame and hoist for multi-bag processing
- Bag/Sack tip door
- Fully load tested bulk bag lifting frames to suit existing hoist equipment
- Hygienic liner clamp

See pages 8, 10 & 11 for a full list of options.



1. Rigging bag



2. Hoisting bag



3. Traversing bag into position



4. Bag loaded & ready to discharge



An optional low height hoist is available where headroom is restricted. The low height unit above has an overall height of under 11.5 ft / 3.5m & discharges 35 in. / 900mm bulk bags.



SIMPLE SUPPORT FRAME

Model (T1)

We offer T1 Simple Support Frame Bulk Bag Dischargers for those applications where:

1. The product to be discharged is completely free-flowing, thus requiring no flow aids.
2. The product is dust-free and thus requires no containment.
3. Uncontrolled 'choke feeding' from bulk bags is acceptable, thus no other regulation of the flow is required once the neck ties are released.
4. There is the continuous presence of an operator.

Our Simple Bulk Bag Discharger Support Frames are robust and can be constructed from epoxy painted carbon steel or stainless steel as the environment dictates.

Bulk bag loading into the frame can be by forklift truck or hoist.

Spiroflow will only offer Simple Support Frames for those applications where we are confident of their suitability. We have so much experience that the design of even our simplest support frames benefit from this.



Customized Model T1 mounted on a wheeled frame that can also be moved by a forklift truck



Model T1 with 'no tools' support arm adjustment and integral sifter



Stainless steel Model T1 with optional bag spout clamp

DISCHARGING SINGLE TRIP BAGS Knife Model (T4)

Single trip bulk bags, are widely used within plant environments for low-value or hazardous products and therefore require a dust-free and controllable emptying method.

Our T4 discharger can empty these disposable bags, which have no bottom spout, without wastage or spillage, even those containing poor flowing products, using various discharge aids and transfer conveyors to suit the application.

Features

- Static or pneumatic knife
- Double dust suppression membrane
- Vibratory discharge aid

Options

- Mobile frame
- Overhead electric bag hoist



1. The T4 consists of a robust frame and discharge dish with a knife to pierce the base of the bag. A double membrane with dust extraction facility ensures total containment of dust emitted during the bag piercing operation.



2. The double membrane ensures that the bag sits deep within the dish and no dust escapes during discharge.

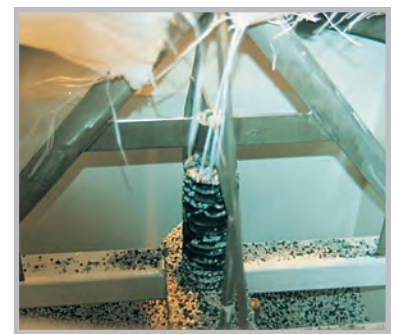

3. The bag is ruptured by the knife and product flows from the discharge dish into the integral transfer conveyor.

DISCHARGING RIGID IBC's, OCTABINS, SACKS & BULK BAGS

Multi-discharger Model (T7)

Our T7 is a versatile emptying system which allows processors to discharge materials from bulk bags, rigid bins, octabins or bags/sacks.

The Multi-discharger employs a controllable discharger and a subframe. A bulk bag or rigid container is placed on the subframe which has fork channels to allow loading onto the discharger. The discharger has an integral hopper and flexible spiral conveyor, which feeds the contents from the bag either volumetrically or by weight to process or packaging machinery.

The discharger also has an interlocked access door through which the operator can untie the spout of a Bulk Bag, or if necessary unload small sacks of product into the conveyor.

This unit is particularly suitable for batching operations requiring ingredients from several sources and methods of supply.

Features

- Adaptor frame for use with rigid bins
- Allows for changing raw material delivery methods
- Sack tip door
- Full dust control
- Integral conveyor or feeder
- Discharge by volume or weight

Options

- Full range of discharge aids
- Bag spout closure bars
- Mobile frame



THE SOLUTION FOR TOTAL DUST CONTAINMENT (optional equipment)

With the exception of the Model T1, all 'Spiroflow' Bulk Bag Dischargers are complete with a dust containment cabinet into which the following optional enhancements can be installed:

1. Yoke Type Spout Closure Bars (patented)



Spout closure bars have several functions: they prevent dust by allowing untying of the bag without product release; their aperture can be set to control the flow rate from the bag; they can close off the spout if used in a batch weighing operation; they allow the bag to be re-tied and removed from the discharging frame.

2. Hygienic Liner Clamp



Our Hygienic Liner Clamps offer easy management of loose liners preventing product spillage and, combined with the tensioning action of the spring-loaded bag support arms, prevent the distension of the liner into downstream equipment. When housed in a cabinet under negative pressure, they offer 'total containment'.

3. Glove Box



A glove box arrangement for untying bags containing hazardous product, preventing operator exposure to product.

4. Liner Remover & Tensioner

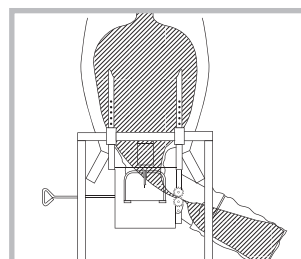

Liners can be removed from the bag after discharge and contained without emission of dust with use of this powered retraction device and compaction facility.

FOR THE MOST HYGIENIC OF APPLICATIONS

Pharmaceutical Dischargers (T10/T11)

At Spiroflow, we specialize in 'high containment' bulk bag filling and bulk bag discharging systems, and offer a range of Bulk Bag (FIBC) Dischargers specifically for use in dairy and pharmaceutical applications.

The worldwide acceptance of bulk bags has brought big changes to bulk materials handling - not least in the pharmaceutical industry where they are replacing the use of rigid IBC's. Bulk bags, and equally important, their filling and discharge systems have made strident advances in hygiene and containment - in fact offering containment levels as good as $25\mu\text{g}/\text{m}^3$. Lined bulk bags avoid cross contamination between batches and eliminate the need for and cost of cleaning/re-validation associated with traditional rigid bins.

However, improperly handled bulk bags can be the cause of dust and spillage during discharge and afterwards during the disposal of empty bags. Our Pharmaceutical Bulk Bag Dischargers offer total containment of bulk bags during discharge and their subsequent removal. They are complete with a liner spout clamping system that ensures total containment. Interlocked, power operated pinch bars are provided to clamp the bulk bag neck so that the neck ties can be released safely. Dependent upon the potency of the active ingredient, releasing the neck ties, cutting open sealed liners, feeding them through the clamp ring and over the discharge spout all takes place within a negative pressure enclosure connected to a HEPA filtration system either through an access door or through a sealed glove box arrangement.



T10 Discharger

The special hygienic design, safety tested bulk bag lifting frame holds bags during discharge.

Horizontally opposed 'V' shaped spout closure bars strangle the bulk bag neck for safe untying.

Bag neck clamping with pharmaceutical dust-tight seal technology for ease of cleaning, replacement and reassembly.

Optional extras include bag liner removal directly into a compactor and filtration arrangements to maintain negative pressure within the dust containment cabinet.

The dust cabinet offers total containment during discharge. A large door and/or glove box give ready access for untying and re-tying bag necks.

Open 'Z' section construction, no dead spots or closed corners. Can be pressure washed.

Bag support arms are spring-loaded and stretch the bag as it empties. This ensures total discharge of the contents.

We offer 3 types of bag massagers (side, base and corner) to promote flow from compacted bags or bags containing difficult materials.

All major components and fixtures and fittings are hand demountable without use of tools. Disassembly is an operator task & no technician is required. It is easily dismantled and reassembled by two operators in minutes.

Hand mountable QR fittings with uniquely identified mating parts.

Folded section construction eliminates tight corner radius.

Discharge can be directly into a process or packing machine below or the discharger can be coupled to an integral conveyor to deliver material to the next process.

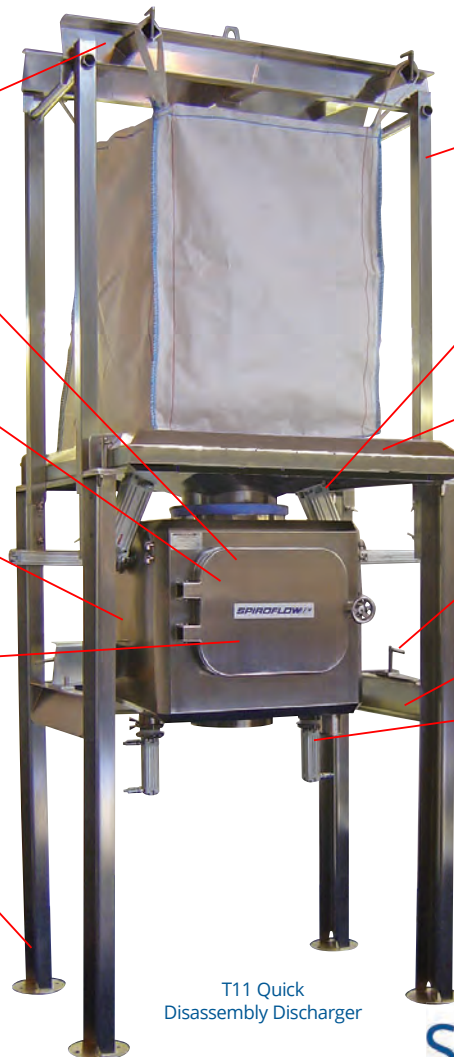

T11 Quick Disassembly Discharger

OPTIONAL EQUIPMENT

1. Bag Massagers



Side massagers

Bag massagers are used to aid the consistent flow of difficult materials from bulk bags and are located either in the base of the support dish, at the corners or on the side frame. They are actuated by pneumatic cylinders and their position and frequency of actuation is fully adjustable. They are particularly effective where storage of bags has created a compaction problem, when traditional (and noisy) vibration may cause further compaction and hinder discharge.



Corner massagers



Base massagers

2. Metering Feeders



Using our own flexible screw conveyor technology, or proprietary equipment, we are able to offer a comprehensive range of gravimetric and volumetric metering feeders for the reliable and accurate dosing of ingredients or additives into mixers, reactors, process vessels or liquid flows.

3. Patented Spout Stretcher



The pneumatic stretching and sealing device assists the flow of poor flowing or very light product through the bag spout and into a downstream vessel, valve or conveyor. It also provides total dust containment of dusty or noxious products.

4. Sieve



An integral vibratory sieve provides assurance that product from a bulk bag is suitably screened for lumps and other impurities before entering the discharge chute.

5. Mobile Frame



A robust mobile frame, with towing facility if required, provides a versatile arrangement for processors who require discharge of bulk bags at several locations. (This option is not available for Type 6 with Integral Hoist).

OPTIONAL EQUIPMENT

6. Mobile Trolley

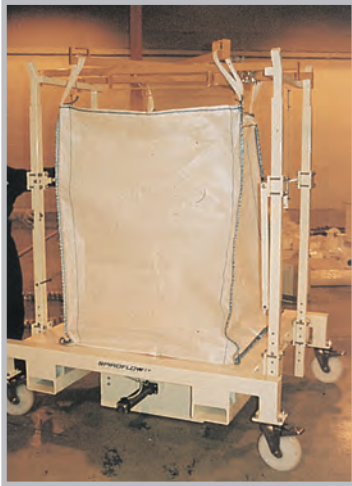

This useful device, often used with a Type 5 Low Loader, can also be supplied as a storage frame for bulk bags. If located on a mezzanine, it can provide direct loading into packaging or process machine hoppers.

7. Lifting Frame & Liner Clamp

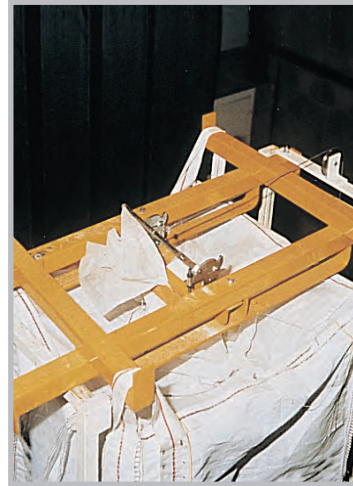

Bulk bags are often supplied with long inner liners which require clamping at the top to prevent fouling the take-off conveyor.

8. Bag Folder



A bag folding table provides a practical solution to bag disposal problems and allows extraction of residual product from the bulk bag.

9. Static Protection



Designed for use in hazardous atmospheres with a Type C static dissipative bag, the earth monitoring device automatically checks that the bag is correctly earthed before discharge can commence.

10. No Tools Support Arm Adjustment



This development significantly reduces the time it takes to alter the height of the support arms to accommodate differing height bags.

11. Bag/Sack Tip Door



We can supply a large bag/sack tip door so that if your supply of bulk bags is interrupted, delivery of raw materials can be accepted in small bags/sacks and handled by the Spiroflow discharger.

CONVEYING EQUIPMENT TO SUIT YOUR PRODUCT

Choosing the right conveyor system to integrate with your Bulk Bag Discharger is determined by several factors, for example:

- Nature of product and flow properties
- Length of conveyor
- Angle of lift
- Flow rate required
- Accuracy and/or consistency of flow rate
- Degradation or separation considerations

These are just some of the criteria which our technical team take into consideration when designing our system. Spiroflow's 45+ plus years of experience in conveying, weighing and metering dry solids and ingredients is your assurance that the right selection is chosen to suit your particular requirements. Our vast database of materials and extensive testing facility is at your disposal, together with our project design team who are geared to handle complete powder handling schemes.

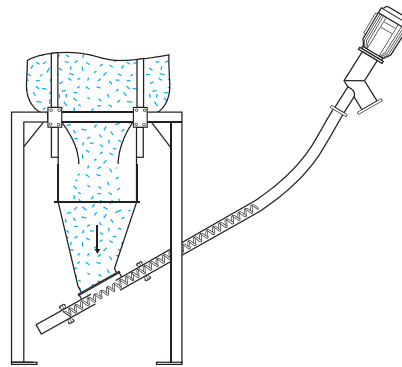

Flexible Screw Conveyor

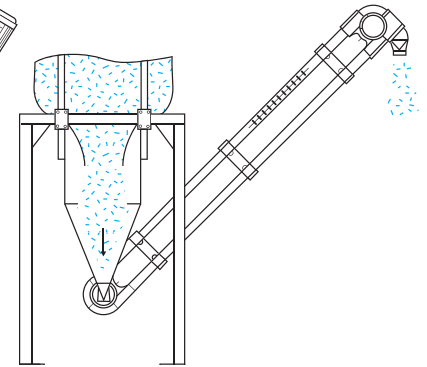

Aero Mechanical Conveyor

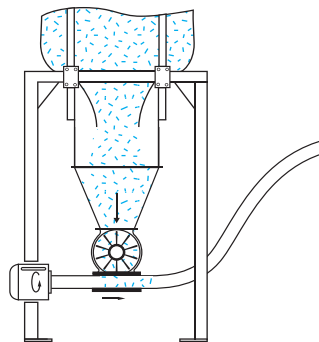

Pneumatic Conveyor

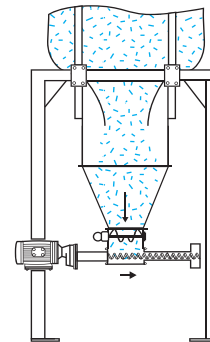

Feeder

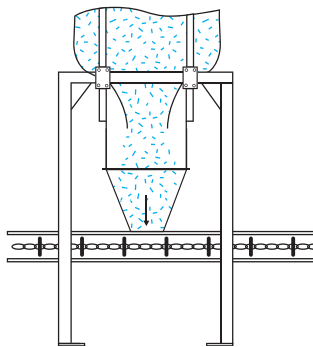

Tubular Drag Conveyor

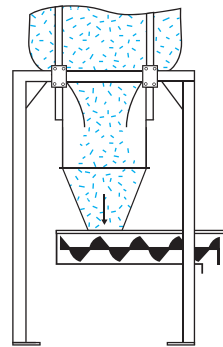

Rigid Screw Conveyor

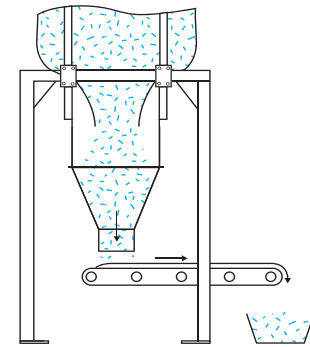

Belt Conveyor

We believe that after-sales support and service form an integral part of our solution. This fundamental belief is the basis of many long-term partnerships we have enjoyed with our customers around the world.

Contact us today to discuss your applications



Spiroflow Limited
Lincoln Way, Clitheroe,
Lancashire, BB7 1QG, UK

+44 (0) 1200 422525
sales@spiroflow.com
www.spiroflow.com



Spiroflow Systems, Inc.
1609 Airport Road
Monroe, NC 28110 USA

(1) 704 246 0900
sales@spiroflow.com
www.spiroflow.com

